

# LAPAROSCOPY PELVISCOPY



[www.mgb-berlin.de](http://www.mgb-berlin.de)

**MGB**

# CONTENT

## LAPAROSCOPY – PELVISCOPY

■ Telescopes	Page 3-4
■ Hand Instruments & Handles	Page 5-7
■ Shafts	Page 8
■ Dissecting- and Grasping Forceps, Ø 10 mm	Page 9
■ Scissors/Biopsy, Forceps, Ø 5 mm	Page 10-11
■ Dissecting- and Grasping Forceps, Ø 5 mm	Page 11-18
■ Insert with Shaft, Ø 3 mm	Page 19
■ Clip and Ligatur, Ø 10 mm, Ø 5 mm, Ø 3 mm	Page 20
■ Cannulas, Fascial Closure, Knot Pusher	Page 21
■ Retractors	Page 22
■ Magnetic Balls – Trocar Sleeves/Silicone and Trumpet Valve	Page 23
■ Flap Valve – Trocar Sleeves	Page 24-25
■ Silicone Valve – Trocar Sleeves	Page 26
■ Flap Valve, Speculum	Page 27
■ Trocars	Page 28
■ Safety Trocars, Verres Needles	Page 29
■ Trocar Accessories	Page 30
■ Sealings	Page 31
■ Suction- and Irrigation	Page 32-33
■ HF-Monopolar Instruments	Page 34
■ Suction- and Irrigation, Accessories	Page 35
■ Bipolar Coagulation Instruments, Ø 5 mm, Ø 3 mm	Page 36-40
■ Bipolar Electrodes, Ø 5 mm, HF-Cables	Page 41
■ Insufflator ML-G	Page 42-43
■ Pump for Laparoscopy	Page 44
■ Morcellator & Accessories	Page 45-47

# TELESCOPES

## LAPALUX SHADOW-TELESCOPE II

**Product**

**Order-No.**

**Description**



429-62500

**LAPALUX SHADOW-Telescope II**

- Direction of view 30°
- Working length: 300 mm
- Connector for Storz/Wolf/ACMI light guide cables
- Sign colour: red

Ø 10 mm

### **This Patent Telescope creates Shadow**

The shade gives more information especially in the depth of field.



### **Shadow Imaging**

The unique design, utilising two light bundles, generates a three dimensional perception of the operating field. Improved orientation may increase work rate and safety.

### **High Resolution**

The high quality optical system guarantees exceptional brightness and full illumination of the finest structures.

### **Autoclavability**

As manufacturer we guarantee full autoclavability at 134 °C / 273 °F. All LAPALUX SHADOW-telescopes are manufactured from stainless steel.



**Circle**

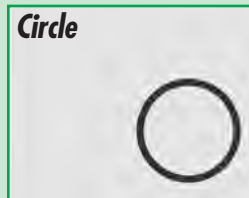

Without Shade



**Ball**

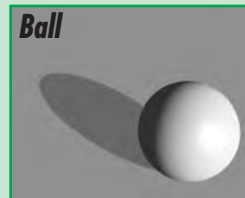

With Shade

### **Three-Dimensional Orientation**

The surgeon is guaranteed a better three-dimensional orientation of the surgical field through the visualization of shadow (natural representation of the pictures).

**Product**

**Order-No.**

**Description**



429-62000

**OP-Telescope**

- Direction of view 0°
- Working length: 270 mm
- Connector for Storz/Wolf/ACMI
- Sign colour: green
- Working channel: Ø 6 mm

Ø 10 mm

# TELESCOPES



## TELESCOPES

### Products

### Order-No.

### Description

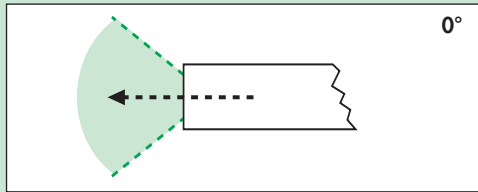

0°

429-60050

#### LAPALUX-Telescope 0° HD

- Direction of view 0°
- Working length: 300 mm
- Connector for Storz/Wolf/ACMI
- Sign colour: green

429-60050 BA

- Working length: 510 mm

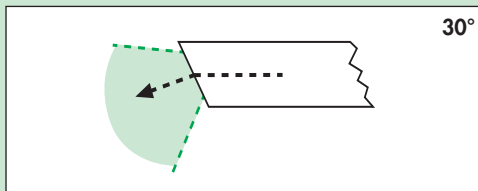

30°

429-61050

#### LAPALUX-Telescope 30° HD

- Direction of view 30°
- Working length: 300 mm
- Connector for Storz/Wolf/ACMI
- Sign colour: red

429-61050 BA

- Working length: 510 mm

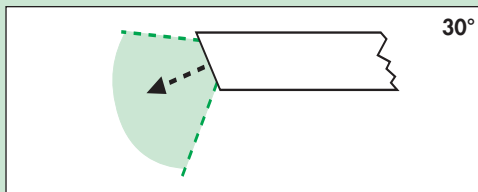

30°

429-66000

#### LAPALUX-Telescope 30°

- Direction of view 30°
- Working length: 310 mm
- Connector for Storz/Wolf/ACMI
- Sign colour: red

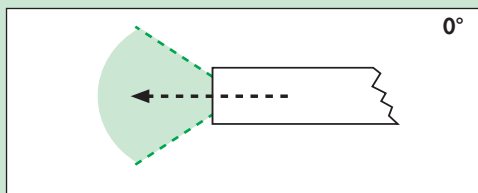

0°

429-67050

#### LAPALUX-Telescope 0° HD

- Direction of view 0°
- Working length: 330 mm
- Connector for Storz/Wolf/ACMI
- Sign colour: green

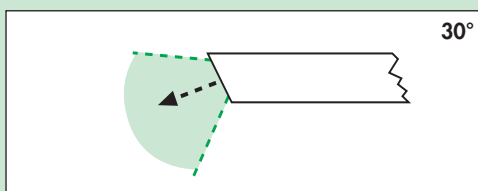

30°

429-68050

#### LAPALUX-Telescope 30° HD

- Direction of view 30°
- Working length: 330 mm
- Connector for Storz/Wolf/ACMI
- Sign colour: red

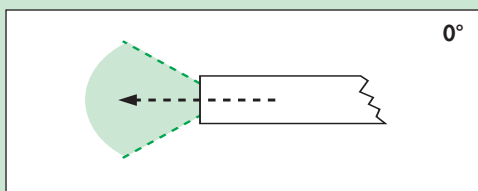

0°

429-63000

#### LAPALUX-Telescope 0°

- Direction of view 0°
- Working length: 300 mm
- Connector for Storz/Wolf/ACMI
- Sign colour: green

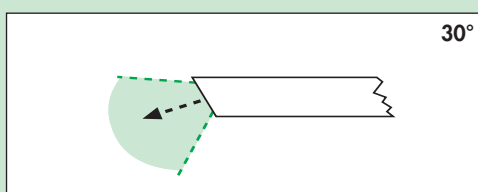

30°

429-64000

#### LAPALUX-Telescope 30°

- Direction of view 30°
- Working length: 300 mm
- Connector for Storz/Wolf/ACMI
- Sign colour: red

Ø 10 mm

NEW

Ø 7 mm

Ø 5 mm

NEW

Ø 2.9 mm

## HAND INSTRUMENTS FOR MIS

*The New Hand Instrument consist of:*

- Handle
- Shaft
- Insert

### Advantages

- 1 Ergonomic developed handle for permanent exhaustless working
  - 2 Ergonomic warped handle-side
  - 3 Ergonomic optimised grip- and side-angle
  - 4 Soft and trapeze similar rounded grip radius avoid bruises
  - 5 Wedge-shaped finger-hollow adjusting wheel for optimal finger-contact with big or small hands
- Oval, rejuvenated fingerings support big as well as small hands
  - Light constructed handle
  - Compact and robust instrument
  - Ratched design for optimal processing
  - Autoclaveable and disassemble
  - Long-lasting materials
  - Exact and long-lasting

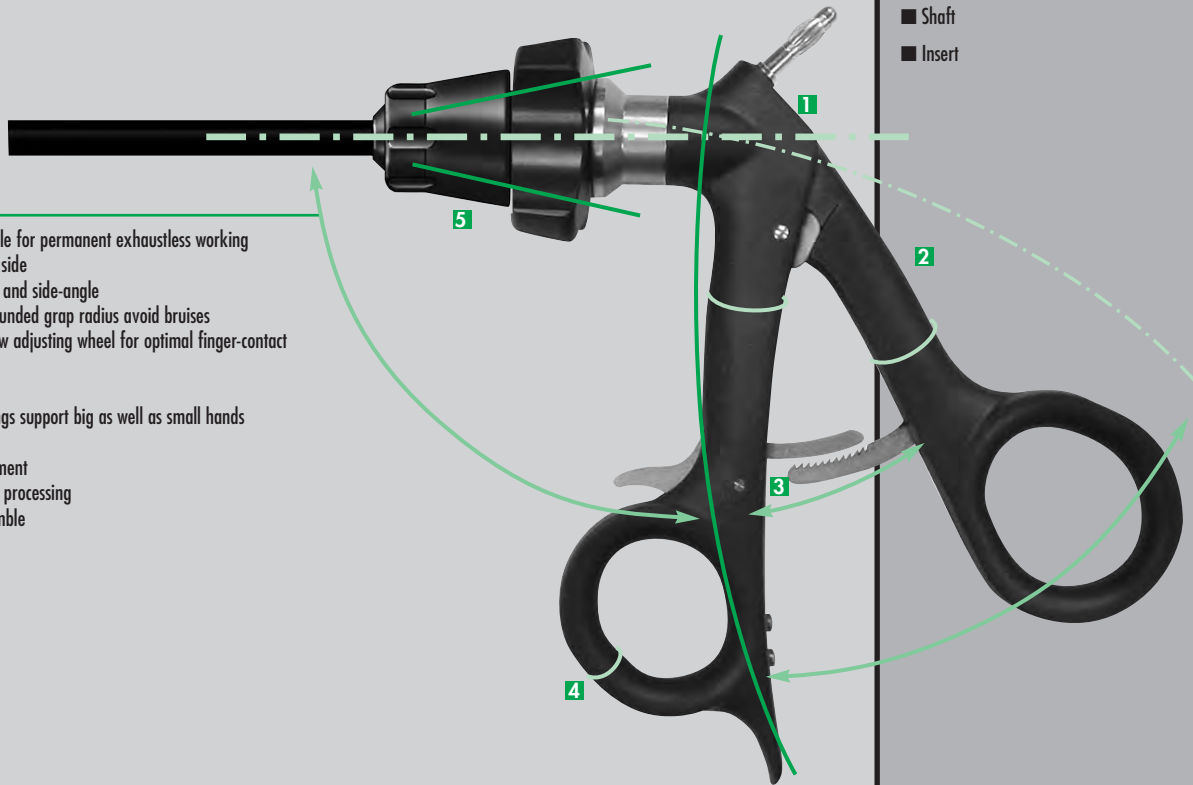

### Instrument-Insert

- Wide range of instruments and cost-savings exchange in case of use up by **exchangeable** inserts for Ø 3 mm, Ø 5 mm and Ø 10 mm shafts.

### Distal-Interface

- In this place, the insert can be screwed into the shaft.

### Shafts

- For this hand instruments-system, isolated and metal shafts are available in diameter of Ø 5 mm and Ø 10 mm. Another advantage is that we have also shaft with Ø 10 mm outer diameter which is made for the Ø 5 mm inserts. Therefore, you will get a very robust instrument.

### Proximal-Interface

- This interface is same by all handles and shafts; because of this, all inserts are able to be connected with the whole handle-spectrum through shaft knob.

### Handles

- There are different handles to our system available and also with different kind of ratches.

### Oblique HF-Connector

- For monopolar coagulation

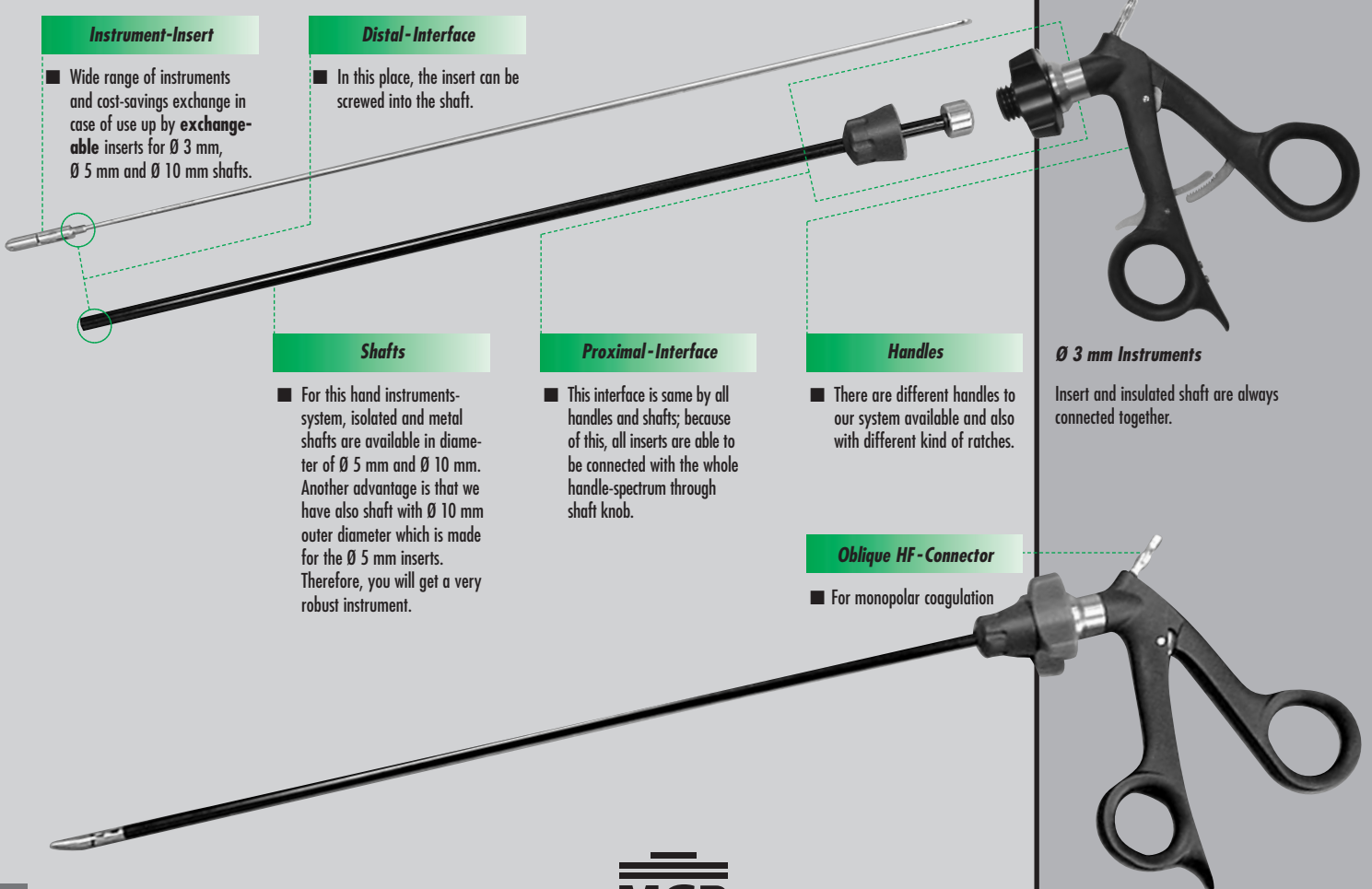

### Ø 3 mm Instruments

Insert and insulated shaft are always connected together.

## INTERFACE AND CONTROL



1.

### **Distal Interface**

- The instrument-inserts are pushed right down into the shafts and screwed to the end.  
**Important:** close the insert-mouth completely, because of impairment cutting!
- The distal interface is different between  $\varnothing$  5 mm and  $\varnothing$  10 mm instruments.



2.

### **Proximal Interface**

- The insert should be closed now and the handle should be opened at the maximum. From now on, put the ball into the gap from an oblique position.  
*Close the handle and screw the shaft knob.*

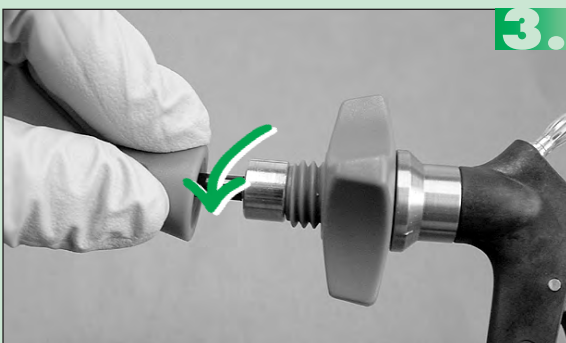

3.

### **Function Control**

- Now, the instrument is completely assembled. Concluding, a function control is to be hold. It will be tested if a relaxed connection between handle and insert exists.

## HANDLES

### Products

### Order-No.

### Description



429-77015

**GRP-Laparoscopic Handle  
Polymer**

- With HF-connection
- Fibre-reinforced



429-77030

**GRP-Laparoscopic Handle  
Polymer with Ratchet**

- With HF-connection
- Fibre-reinforced



429-75003

**Metal Handle**



429-75002

**Metal Handle with Ratchet**

## SHAFTS

Products

Order-No.

Description



429-75035

**Metal Shaft with Shaft Knob**

- Working length: 330 mm
- Ø 5 mm



429-75031

**Metal Shaft with Shaft Knob**

- Working length: 330 mm
- Ø 10 mm



429-75065  
429-75065/22  
429-75065/44

**Insulated Shaft with Shaft Knob Ø 5 mm**

- Working length: 330 mm
- Working length: 220 mm
- Working length: 440 mm



429-75062

**Insulated Shaft with Shaft Knob**

① Ø 10-5 mm

- Working length: 330 mm

Ø 10 mm

429-75061  
429-75061/44

- Working length: 330 mm
- Working length: 440 mm

**Attention** ⓘ

Shaft outer-diameter Ø 10 mm:  
for Ø 5 mm inserts

**Shaft Knobs:**

■ For Ø 10 mm inserts separate delivery,  
**Order-No.: 429-75081**

■ For Ø 3-/Ø 5 mm inserts separate delivery,  
**Order-No.: 429-75085**



# INSERTS

## DISSECTING- AND GRASPING FORCEPS

Inserts

Order-No.

Description

Ø 10 mm



429-75263

**Spoon Grasping Forceps**

- Single action

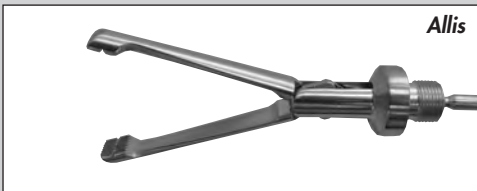

**Allis**

429-75215

**Grasping Forceps**

- Double action

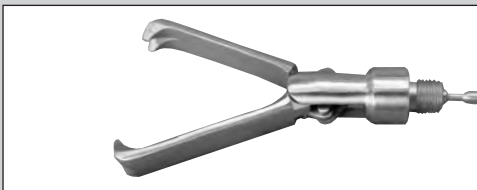

429-75281 (330 mm)  
429-75281/44 (440 mm)

**Claw Forceps**

- 2 to 3 teeth
- Sharp
- Double action



**Mixer**

429-75165

**Dissecting Forceps 90°**

- Right-angled 90°
- Double action

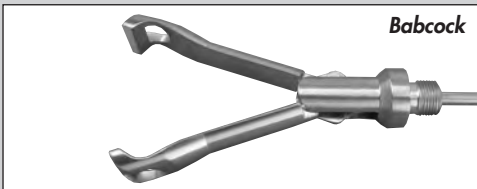

**Babcock**

429-75191

**Grasping Forceps**

- Double action



**Maryland**

429-75164

**Grasping Forceps**

- Slight curved
- Double action

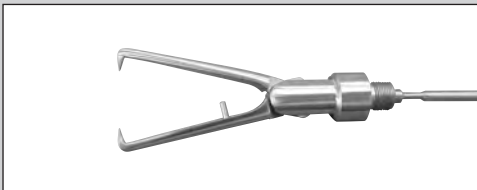

429-75282  
429-75282/44

**Tenaculum**

# INSERTS

## SCISSORS/BIOPSY

Inserts

Order-No.

Description

Ø 5 mm

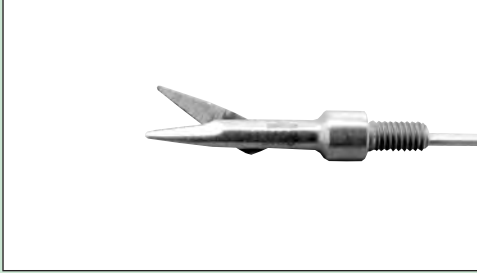

429-75301

**Micro Scissors Straight**

- Single action



429-75154

**Endo Scissors**

- Curved



429-75111

**Peritoreal Scissors**

- Straight
- Serrated jaw
- Single action



429-75261 (330 mm)  
429-75261/22 (220 mm)  
429-75261/44 (440 mm)

**Hook Scissors**

- Hardened
- Single action



**Metzenbaum**

429-75152

**Scissors**

- Straight
- Double action

# INSERTS

## SCISSORS/BIOPSY FORCEPS

Inserts

Order-No.

Description

Ø 5 mm

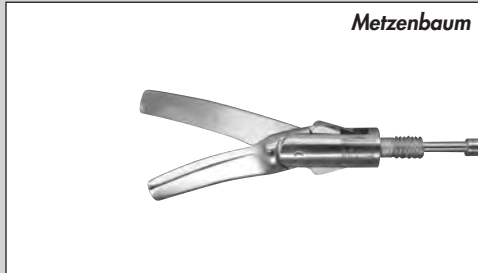

429-75153 (330 mm)  
429-75153/22 (220 mm)  
429-75153/44 (440 mm)

Scissors  
■ Curved  
■ Double action



429-75158

Preparation Scissors  
■ "Special-cut"  
■ Curved  
■ Double action

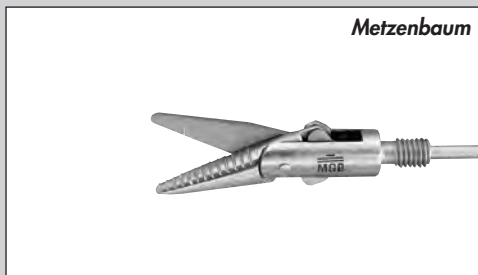

429-75155

Scissors Heavy  
■ Straight  
■ Heavy blades



429-75273

Biopsy Forceps  
■ Single action



429-75271

Biopsy Forceps  
■ Single action

# INSERTS

## DISSECTING- AND GRASPING FORCEPS

Inserts

Order-No.

Description

Ø 5 mm



429-75274

**Biopsy Forceps**

- With pin
- Single action



429-75275

**Biopsy Forceps**

- Spoon jaw
- Double action

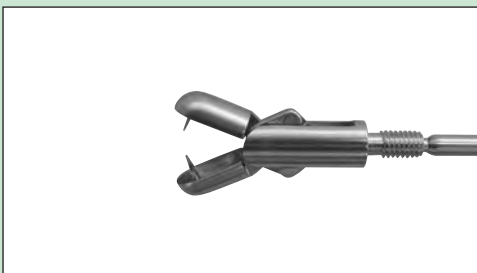

429-75272

**Biopsy Forceps**

- Spoon jaw with pin
- Double action



429-75238

**Alligator Grasping- and Biopsy Forceps**

- Double action



429-75121

**Dissecting Forceps**

- Slim
- Single action

# INSERTS

## DISSECTING- AND GRASPING FORCEPS

**Inserts**

**Order-No.**

**Description**

Ø 5 mm

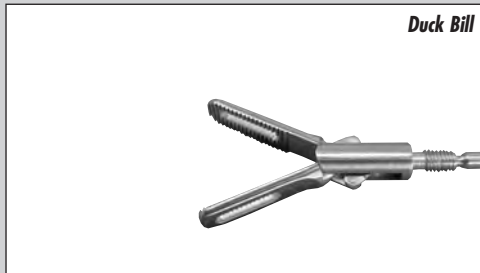

429-75237 (330 mm)  
429-75237/22 (220 mm)  
429-75237/44 (440 mm)

**Dissecting- and Grasping Forceps**

- Fenestrated
- Double action

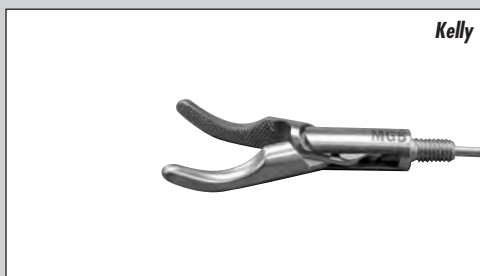

429-75166

**Dissecting- and Grasping Forceps**



429-75167

**Dissecting- and Grasping Forceps**



429-75214

**Atraum. Grasping Forceps**

- Taper off
- Single action



429-75175

**Claw Forceps Aggressive**

- 2 to 3 teeth
- Sharp
- Single action
- Second teeth row

# INSERTS

## DISSECTING- AND GRASPING FORCEPS

Inserts

Order-No.

Description

Ø 5 mm



429-75171

**Claw Forceps**

- 2 to 3 teeth
- Sharp
- Single action



429-75232 (330 mm)  
429-75232/22 (220 mm)  
429-75232/44 (440 mm)

**Dissecting- and Grasping Forceps**

- Blunt
- Double action

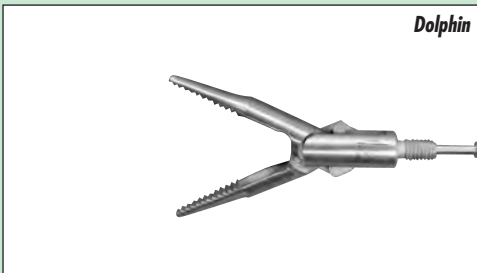

429-75201

**Dissecting Forceps, Short**

- With spoon
- Double action



429-75202

**Dissecting Forceps, Long**

- With spoon
- Double action



429-75203

**Dissecting Forceps**

- With spoon
- Pointed
- Double action

# INSERTS

## DISSECTING- AND GRASPING FORCEPS

**Inserts**

**Order-No.**

**Description**

Ø 5 mm



429-75204

**Dissecting Forceps**

- With spoon
- Blunt
- Double action



429-75291

**Atraum. Grasping Forceps**

- Slim
- Double action

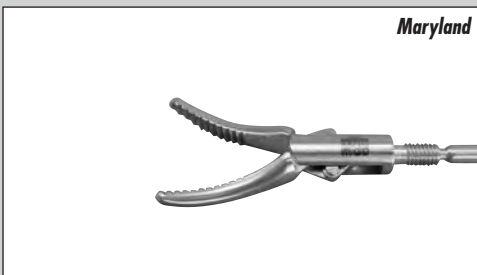

**Maryland**

429-75162 (330 mm)  
429-75162/22 (220 mm)  
429-75162/44 (440 mm)

**Dissecting Forceps**

- Short jaw
- Curved left
- Double action



**Dorsey**

429-75244

**Intestinal Forceps**

- Jaw length: 30 mm
- Double action
- Fenestrated



**De Bakay**

429-75222

**Atraum. Intestinal Forceps**

- Jaw length: 30 mm
- Double action

429-75223

- Jaw length: 60 mm

# INSERTS

## DISSECTING- AND GRASPING FORCEPS

**Inserts**

**Order-No.**

**Description**

**Ø 5 mm**



429-75231

**Dissecting- and Grasping Forceps**

- Short
- Double action

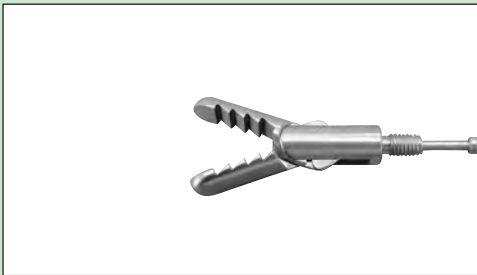

429-75236

**Alligator Grasping Forceps**

- Double action

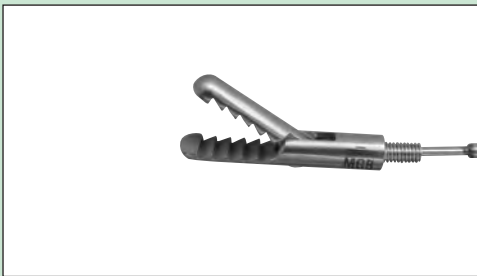

429-75241

**Alligator Grasping Forceps**

- Single action



Cobra

429-75131

**Grasping Forceps**

- 2 to 3 teeth
- Hardened
- Double action

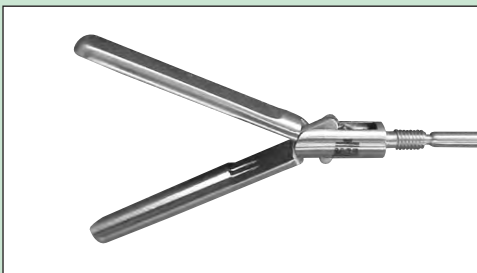

429-75221

**Atraum. Grasping Forceps**

- Double action



# INSERTS

## DISSECTING - AND GRASPING FORCEPS

**Inserts**

**Order-No.**

**Description**

Ø 5 mm



429-75234 (330 mm)  
429-75234/22 (220 mm)  
429-75234/44 (440 mm)

**Grasping Forceps**

- Fenestrated
- Double action



429-75242

**Endo Grasper**

- Fenestrated
- Double action



429-75235 (330 mm)  
429-75235/22 (220 mm)  
429-75235/44 (440 mm)

**Grasping Forceps**

- Double action



429-75211

**Atraum. Grasping Forceps**

- Double action



429-75183

**Bowel Grasping Forceps**

- Double action

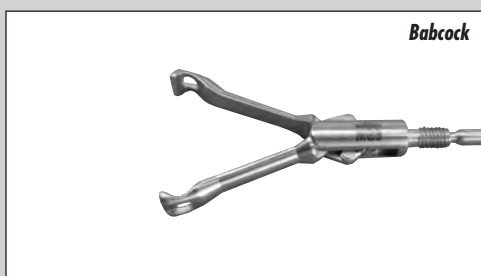

429-75208

**Grasping Forceps**

# INSERTS

## DISSECTING - AND GRASPING FORCEPS

**Inserts**

**Order-No.**

**Description**

**Ø 5 mm**



429-75245

**Micro Grasping Forceps**



429-75240

**Atraum. Grasping Forceps**

■ Wavy teeth

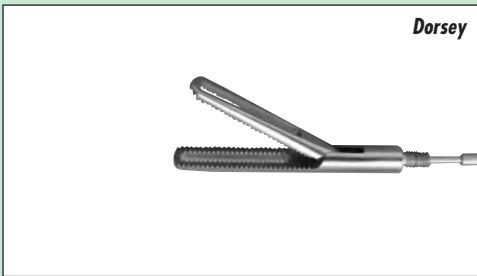

429-75239

**Grasping Forceps**

■ Fenestrated  
■ Single action

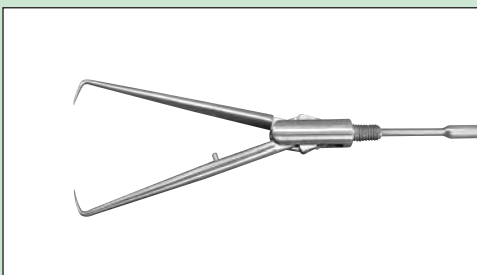

429-75283

**Insert Tenaculum**

■ Ø 5 mm for 330 mm shafts

429-75283/44

■ Ø 5 mm for 440 mm shafts

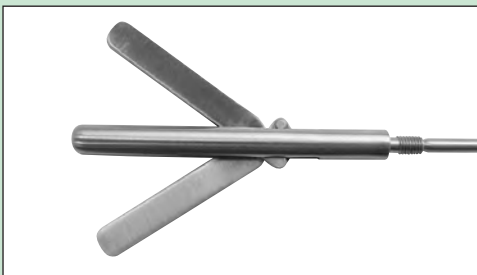

429-75305

**Retractor Insert with 3 Fingers**

## INSERT WITH SHAFT

**Inserts**

**Order-No.**

**Description**

**Ø 3 mm**



429-73411

**Scissors**

- Irrigation port

- Working length: 330 mm



429-73421

**Biopsy Forceps**

- Irrigation port



429-73381

**Grasping Forceps**

- Straight
- Serrated
- Irrigation port



429-73391

**Grasping Forceps**

- Curved
- Serrated
- Irrigation port



429-73401

**Atraum. Grasping Forceps**

**Ø 3 mm Instruments**

Inserts and insulated shafts are always connected together.

## CLIP AND LIGATUR

### Products

### Order-No.

### Description

Ø 10 mm/Ø 5 mm/Ø 3 mm

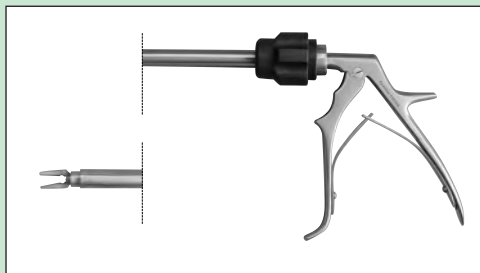

429-70370

#### Clip-Applicator

- For SLS-Clips
- Medium-large
- Rotable
- Disassemble

429-70379

#### SLS Titan Clip

- Medium-large
- Box with 20 cartridges with 6 clips

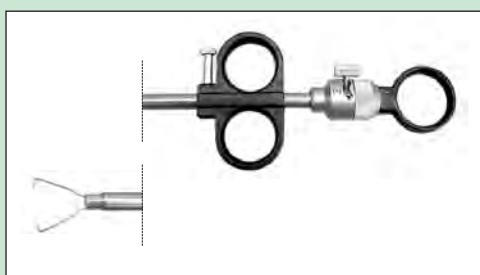

429-70380

#### Ring-Applicator

- Ø 6.5 mm
- Length: 287 mm

429-70382

#### Ring-Applicator

- Ø 6.0 mm
- Length: 350 mm
- For OP-Laparoscope
- Order-Nr.: 429-62000

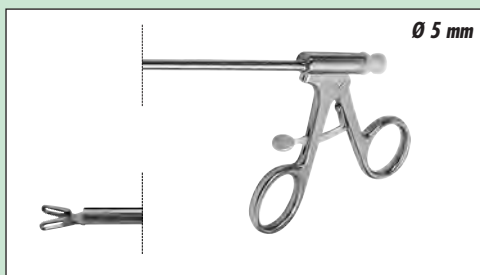

429-70305

#### Cholangiogram Clamp

- Ø 5 mm
- Channel for cholangiocatheter
- Handle with ratchet
- Assemble
- 6 Fr. Channel

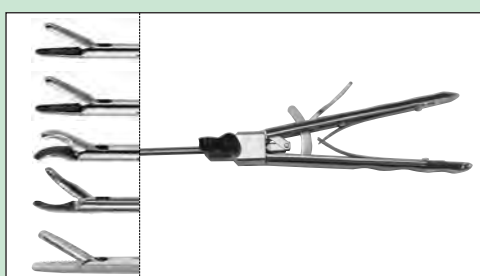

429-73430 (Ø 3 mm)

429-75310 (Ø 5 mm)

429-75350 (Ø 5 mm)

429-75340 (Ø 5 mm)

429-75360 (Ø 5 mm)

#### Axial Needle Holder with Rinsing Channel

- Not detachable
- Straight
- Straight
- Left
- Right
- Straight convex/concav shaped

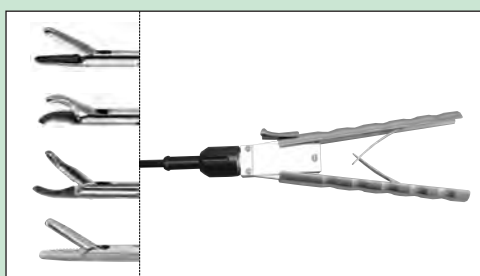

429-77310

429-77350

429-77340

429-77360

#### Needle Holder in 3 Components Disassemble

- Straight
- Left
- Right
- Straight convex/concav shaped

Tungsten Carbide

## CANNULAS

### Products

### Order-No.

### Description

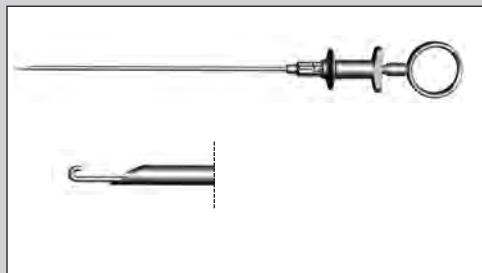

429-23810

#### Fascial Closure Device

- Ø 2.3 mm
- Working length: 140 mm

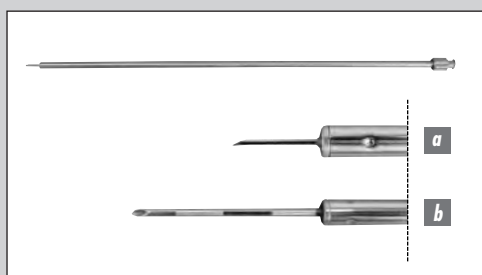

**a** 429-14530

#### **a** Puncture Cannula

- Ø 5 mm
- Needle diameter: 1.0 mm
- Working length: 300 mm

**b** 429-14520

#### **b** Puncture Cannula

- Ø 5 mm
- Needle diameter: 1.5 mm
- Working length: 300 mm



429-16730

#### Probe Rod

- Graduated
- Diameter: Ø 5 mm
- Working length: 300 mm

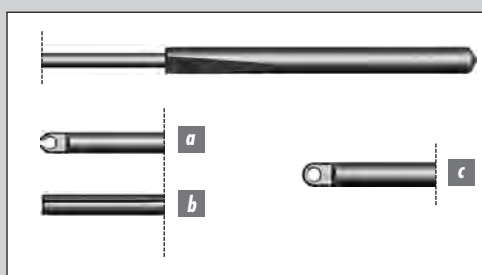

**a** 429-40270

#### Knot Pusher

- Ø 4 mm
- Working length: 330 mm

**b** 429-40271

**a** ■ Open loop

**c** 429-40272

**b** ■ Slot

**c** ■ Closed loop

## RETRACTORS

Products

Order-No.

Description



429-16905

„Fan“ Retractor with 3 Fingers

- Diameter: 5 mm
- Working length: 340 mm



429-16901

„Fan“ Retractor with 5 Fingers

- Diameter: 10 mm
- Working length: 380 mm



429-16915

„Fan“ Retractor with 3 Fingers

- Diameter: 10 mm
- Working length: 340 mm
- Vertical up to 50° adjustable



429-16911

„Fan“ Retractor with 5 Fingers

- Diameter: 10 mm
- Working length: 380 mm
- Vertical up to 50° adjustable

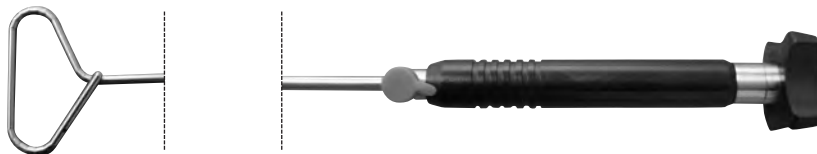

429-16925

Flex Retractor

- Diameter: 5 mm
- With irrigation port

## MAGNETIC BALL – TROCAR SLEEVES

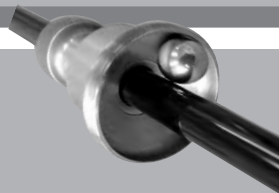

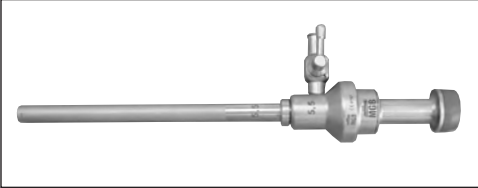
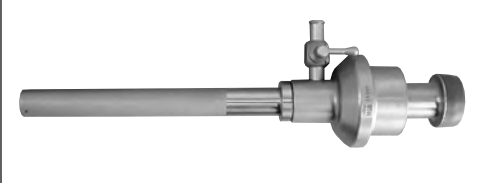
Products	With Luer Stopcock Order-No.	Diameter	Working Length	Description
	429-24055	5.5 mm	95.0 mm	<b>Trocar Sleeve with Magnetic Ball</b> ■ Stainless steel
	429-24100	10.0 mm	97.0 mm	<b>Trocar Sleeve with Magnetic Ball</b> ■ Stainless steel

## SILICONE VALVE TROCAR-SLEEVE

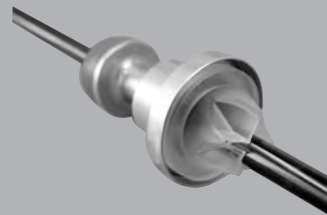

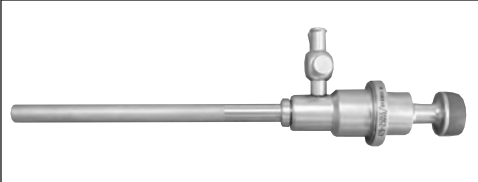
Products	With Luer Stopcock Order-No.	Diameter	Working Length	Description
	429-25055	5.5 mm	95.0 mm	<b>Trocar Sleeve with Silicone Valve</b> ■ Stainless steel

## TRUMPET VALVE – TROCAR SLEEVE

Products	With Luer Stopcock Order-No.	Diameter	Working Length	Description
	429-40005	5.5 mm	95.0 mm	<b>Metal Shaft</b> ■ Straight
	429-40013	10.0 mm	97.0 mm	
	429-40014	11.0 mm	101.0 mm	

## FLAP VALVE – TROCAR SLEEVES

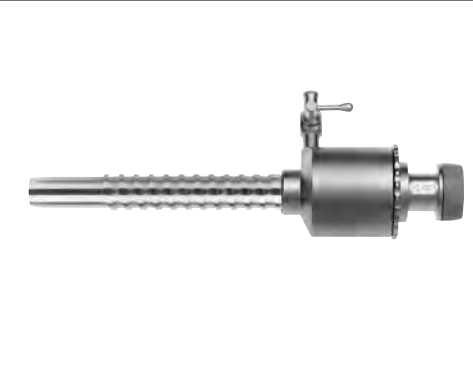
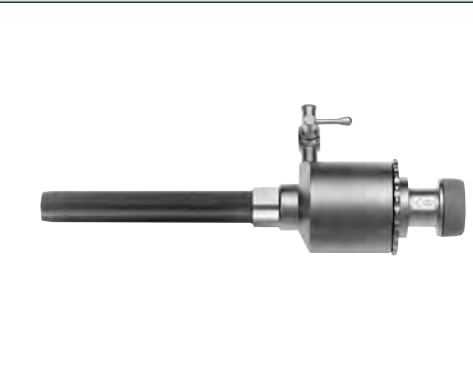
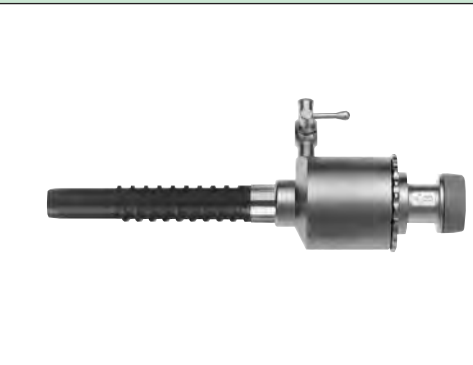
Products	With	Diameter	Working Length	Description
	Luer Stopcock			
	Order-No.			
	429-40201	3.5 mm	70.0 mm	<b>Metal Shaft</b>
	429-45201	5.0 mm	92.0 mm	■ Straight
	429-40001	5.5 mm	95.0 mm	
	429-40004	7.0 mm	95.0 mm	
	429-45001	10.0 mm	97.0 mm	
	429-40002	11.0 mm	101.0 mm	
	429-40003	12.5 mm	98.0 mm	
	429-40011	5.5 mm	95.0 mm	<b>Metal Shaft</b>
	429-40012	11.0 mm	101.0 mm	■ With retaining thread
	429-41012	12.5 mm	98.0 mm	
	429-40051	5.5 mm	95.0 mm	<b>Plastic Shaft</b>
	429-40052	11.0 mm	101.0 mm	■ Straight
	429-40054	12.5 mm	98.0 mm	
	429-40061	5.5 mm	95.0 mm	<b>Plastic Shaft</b>
	429-40062	11.0 mm	101.0 mm	■ With retaining thread
	429-40064	12.5 mm	98.0 mm	





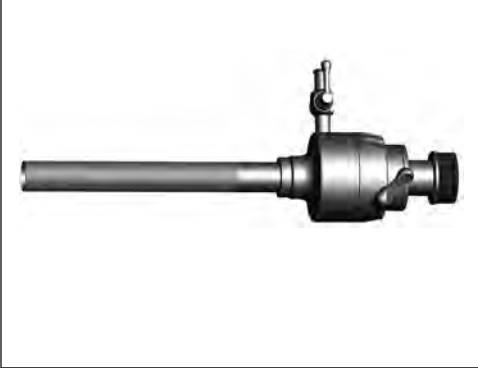
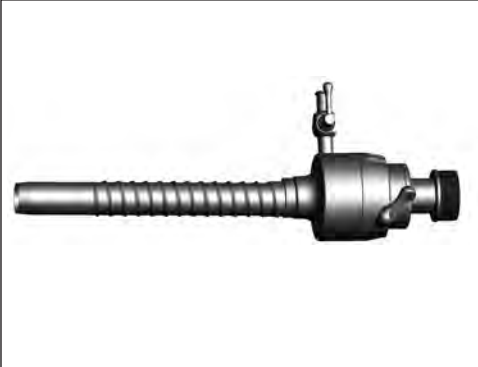
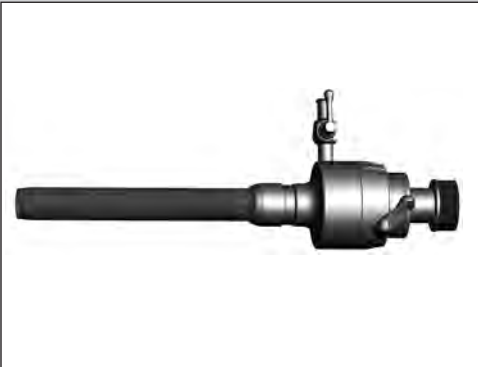
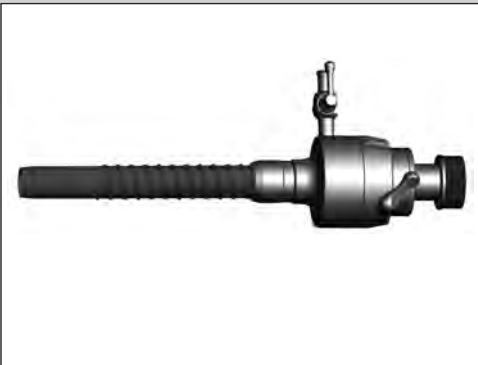

## FLAP VALVE – TROCAR SLEEVES

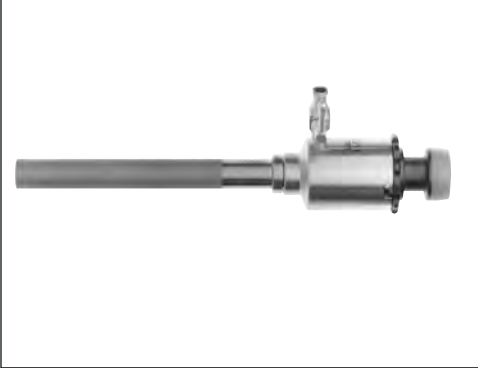

Products	With	Diameter	Working Length	Description
	Luer Stopcock			
	Order-No.			
	429-40202	3.5 mm	70.0 mm	<b>Metal Shaft</b>
	429-40020	5.0 mm	92.0 mm	■ Straight
	429-40021	5.5 mm	95.0 mm	■ With manual opening
	429-40025	10.0 mm	97.0 mm	
	429-40022	11.0 mm	101.0 mm	
	429-40024	12.5 mm	98.0 mm	
	429-40021/15	5.5 mm	150.0 mm	<b>Stainless Steel</b>
	429-40022/15	11.0 mm	150.0 mm	<b>Bariatric Surgery</b>
	429-40024/15	12.5 mm	150.0 mm	
	429-40031	5.5 mm	95.0 mm	<b>Metal Shaft</b>
	429-40032	11.0 mm	101.0 mm	■ With retaining thread
	429-40034	12.5 mm	98.0 mm	■ With manual opening
	429-40071	5.5 mm	95.0 mm	<b>Plastic Shaft</b>
	429-40072	11.0 mm	101.0 mm	■ Straight
	429-40074	12.5 mm	98.0 mm	■ With manual opening
	429-40081	5.5 mm	95.0 mm	<b>Plastic Shaft</b>
	429-40082	11.0 mm	101.0 mm	■ With retaining thread
	429-40084	12.5 mm	98.0 mm	■ With manual opening

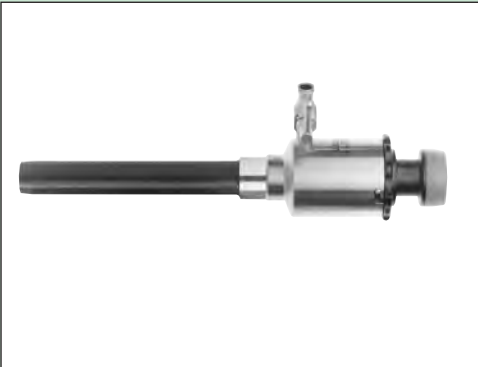
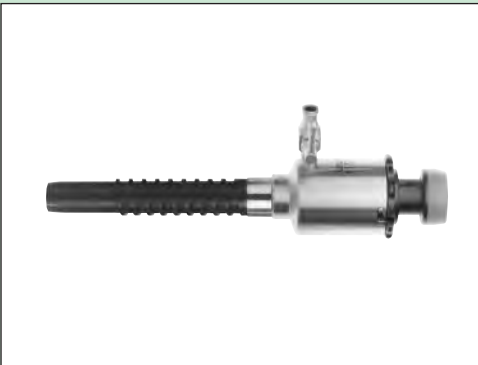
## SILICONE VALVE – TROCAR SLEEVES

Products	With	Diameter	Working Length	Description
	Luer Stopcock			
	Order-No.			
	429-40280	3.5 mm	70.0 mm	<b>Metal Shaft</b>
	429-40281	5.0 mm	92.0 mm	■ Straight
	429-40282	5.5 mm	95.0 mm	
	429-40283	10.0 mm	97.0 mm	
	429-40284	11.0 mm	101.0 mm	
	429-40285	12.5 mm	98.0 mm	
	429-40306	5.5 mm	95.0 mm	<b>Metal Shaft</b>
	429-40308	11.0 mm	101.0 mm	■ With retaining thread
	429-40309	12.5 mm	98.0 mm	
	429-40311	5.5 mm	95.0 mm	<b>Plastic Shaft</b>
	429-40313	11.0 mm	101.0 mm	■ Straight
	429-40314	12.5 mm	98.0 mm	
	429-40321	5.5 mm	95.0 mm	<b>Plastic Shaft</b>
	429-40323	11.0 mm	101.0 mm	■ With retaining thread
	429-40324	12.5 mm	98.0 mm	

# TROCARS

## BIG DIAMETER FLAP VALVE – TROCAR SLEEVES WITH MANUAL OPENING

Products	With Luer Stopcock	Diameter	Working Length	Description
	Order-No.			
	429-40041	15.0 mm	110.0 mm	<b>Metal Shaft</b>
	429-40042	20.0 mm	120.0 mm	<b>■ Straight</b> <b>Stainless Steel</b>
	429-23900			<b>Abdominal Speculum</b>



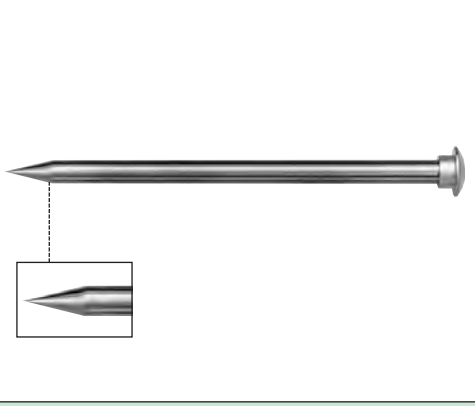
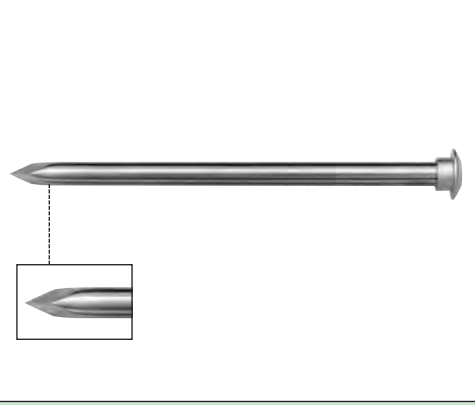
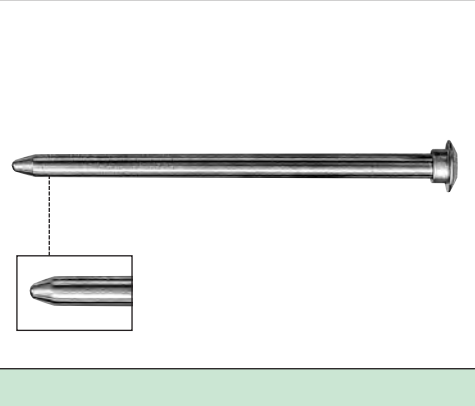
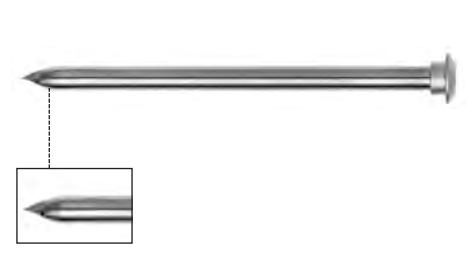

## TROCARS

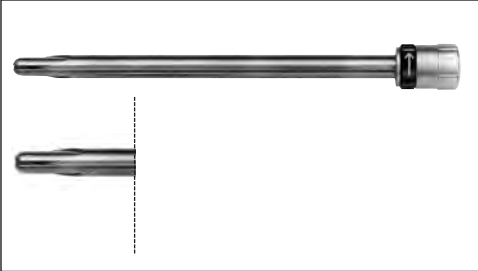
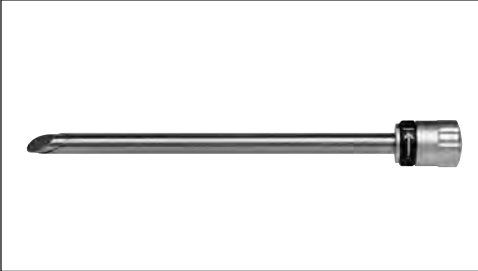
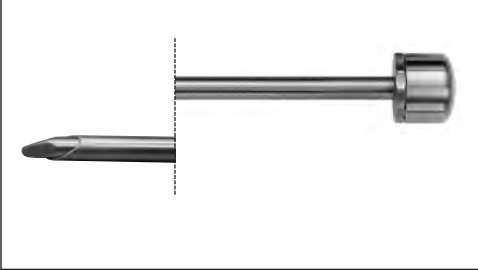
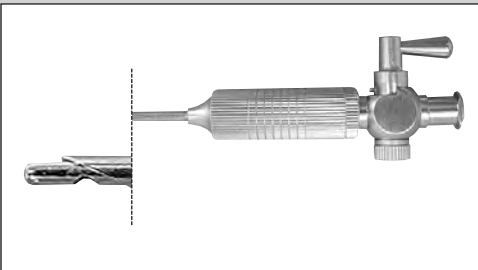
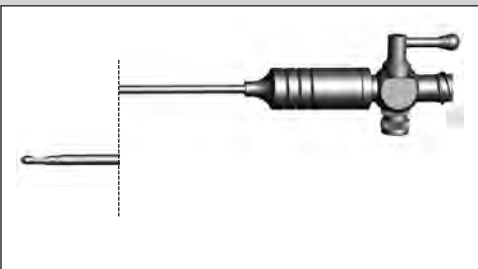
Products	Order-No.	Diameter	For Sleeve Working Length	Description
	429-40203	3.5 mm	70.0 mm	<b>Trocar</b>
	429-40130	5.0 mm	92.0 mm	■ Conical
	429-40131	5.5 mm	95.0 mm	
	429-40170	7.0 mm	95.0 mm	
	429-40134	10.0 mm	97.0 mm	
	429-40133	11.0 mm	101.0 mm	
	429-40137	12.5 mm	98.0 mm	
	429-40131/15	5.5 mm	150.0 mm	
	429-40133/15	11.0 mm	150.0 mm	<b>Bariatric Surgery</b>
	429-40137/15	12.5 mm	150.0 mm	
	429-40204	3.5 mm	70.0 mm	<b>Trocar</b>
	429-40136	5.0 mm	92.0 mm	■ Pyramidal
	429-40141	5.5 mm	95.0 mm	
	429-40159	7.0 mm	95.0 mm	
	429-40138	10.0 mm	97.0 mm	
	429-40143	11.0 mm	101.0 mm	
	429-40139	12.5 mm	98.0 mm	
	429-40141/15	5.5 mm	150.0 mm	
	429-40143/15	11.0 mm	150.0 mm	<b>Bariatric Surgery</b>
	429-40139/15	12.5 mm	150.0 mm	
	429-40146	3.5 mm	70.0 mm	<b>Trocar</b>
	429-40147	5.0 mm	92.0 mm	■ Conical blunt
	429-40148	5.5 mm	95.0 mm	
	429-40160	7.0 mm	95.0 mm	
	429-40149	10.0 mm	97.0 mm	
	429-40151	11.0 mm	101.0 mm	
	429-40152	12.5 mm	98.0 mm	
	429-40153	5.0 mm	92.0 mm	<b>Trocar</b>
	429-40154	5.5 mm	95.0 mm	■ Pyramidal with hollow grinding
	429-40163	7.0 mm	95.0 mm	
	429-40135	10.0 mm	97.0 mm	
	429-40156	11.0 mm	101.0 mm	
	429-40155	12.5 mm	98.0 mm	

## SAFETY TROCARS

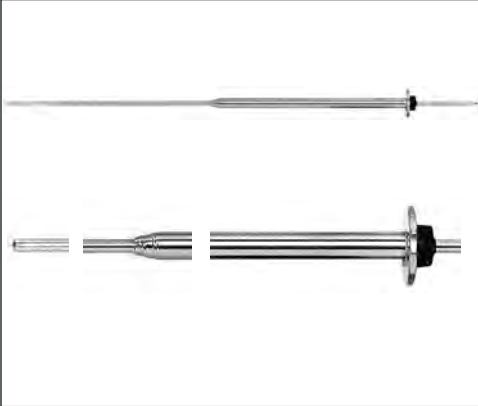
Products	Order-No.	Diameter	For Sleeve Working Length	Description
	Order-No.			
	429-40103	5.0 mm	92.0 mm	<b>Trocar</b>
	429-40101	5.5 mm	95.0 mm	■ Pyramidal
	429-40104	10.0 mm	97.0 mm	
	429-40102	11.0 mm	101.0 mm	
	429-40105	12.5 mm	98.0 mm	
	429-40113	5.0 mm	92.0 mm	<b>Trocar</b>
	429-40111	5.5 mm	95.0 mm	■ Half-moon
	429-40114	10.0 mm	97.0 mm	
	429-40112	11.0 mm	101.0 mm	
	429-40115	12.5 mm	98.0 mm	
	429-40125	5.5 mm	95.0 mm	<b>Trocar</b>
	429-40126	10.0 mm	97.0 mm	■ V-style
	429-40127	11.0 mm	101.0 mm	
	670-95341 (100 mm)			<b>Verres Needle</b>
	670-95342 (120 mm)			Ø 2 mm
	670-95340 (150 mm)			
	670-95351 (100 mm)			<b>Verres Needle</b>
	670-95352 (120 mm)			Ø 2 mm
	670-95350 (150 mm)			<b>Stainless Steel</b>





## TROCAR ACCESSORIES

Products	Order-No.	Diameter	Description	
	429-23210	5.0 mm - 10.0 mm	<b>Dilatation Sleeve with Rod</b>	
	429-23211	5.0 mm - 11.0 mm		
	429-23212	11.0 mm - 15.0 mm		
	429-23213	10.0 mm - 15.0 mm		
	429-23214	5.0 mm - 15.0 mm		
	429-23215	11.0 mm - 20.0 mm		
	429-23216	10.0 mm - 20.0 mm		
	429-23217	5.0 mm - 20.0 mm		
	429-23011	10.0 mm - 5.5 mm	<b>Reduction Sleeve</b>	
	429-40150	11.0 mm - 5.5 mm		
	429-23013	12.5 mm - 10.0 mm		
	429-23014	12.5 mm - 5.5 mm		
	429-16600	5.0 mm - 4.0 mm		<b>Applicator for Endo-Ligatur</b>
	429-23510	5.0 mm	<b>Trocar Stop</b> 35.0 mm	
	429-23511	5.5 mm		
	429-23512	10.0 mm		
	429-23513	11.0 mm		
	429-23514	12.5 mm		
	429-23115	10.0 mm - 5.5 mm	<b>Reducer with Silicone Strap</b>	
	429-23116	11.0 mm - 5.5 mm		
	429-23117	12.5 mm - 5.5 mm		
	429-23118	12.5 mm - 10.0 mm		
	429-23119	12.5 mm/11.0 mm/10.0 mm to 5,5 mm	<b>Slide Reducer</b>	
	429-23120	12.5 mm to 10.0 mm		

### Reduction Sleeve

- Order-No.:
- 429-23015 (15.0 mm - 10.0 mm)
- 429-23016 (15.0 mm - 5.50 mm)
- 429-23017 (20.0 mm - 10.0 mm)
- 429-23018 (20.0 mm - 5.50 mm)

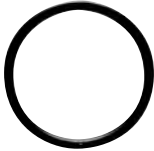
## SEALINGS

Products	Order-No.	Diameter	Description
	Order-No.		
	429-90023 (10 pcs.)	3.0 mm/3.5 mm	<b>Sealing Caps</b> ■ For all trocar sleeves
	429-90001 (10 pcs.)	5.0 mm/5.5 mm	
	429-90022 (2 pcs.)	10.0 mm/10.5 mm/11.0 mm	
	429-90027 (10 pcs.)	12.5 mm	
	429-90021 (2 pcs.)	15.0 mm	
	429-90020 (2 pcs.)	20.0 mm	
	429-90030	3.0 mm/3.5 mm	<b>Seal (1 pcs.)</b> ■ For trocar sleeves on page 25/26
	429-90032	5.0 mm/5.5 mm	
	429-90034	10.0 mm/11.0 mm/12.5 mm	
	429-90037	15.0 mm	
	429-90038	20.0 mm	
	429-90040	3.0 mm/3.5 mm	<b>O-Ring (1 pcs.)</b> ■ For flap valve trocar sleeves on page 25/26
	429-90042	5.0 mm/5.5 mm	
	429-90044	10.0 mm/11.0 mm/12.5 mm	
	429-90047	15.0 mm	
	429-90048	20.0 mm	
	429-90017 (5 pcs.)	3.5 mm/5.5 mm	<b>Silicone Valve</b> ■ For trocar sleeves on page 27
	429-90018 (5 pcs.)	10.0 mm/12.5 mm	
	429-90019 (10 pcs.)		<b>Silicone Valve</b> ■ For Order-No.: 429-25055

## SUCTION- AND IRRIGATION

Products

Order-No.

Description

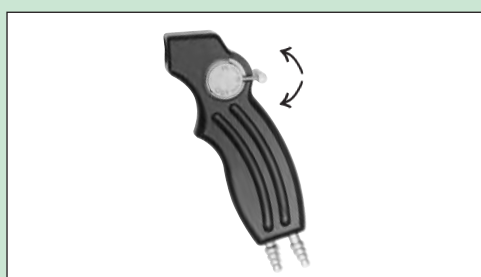
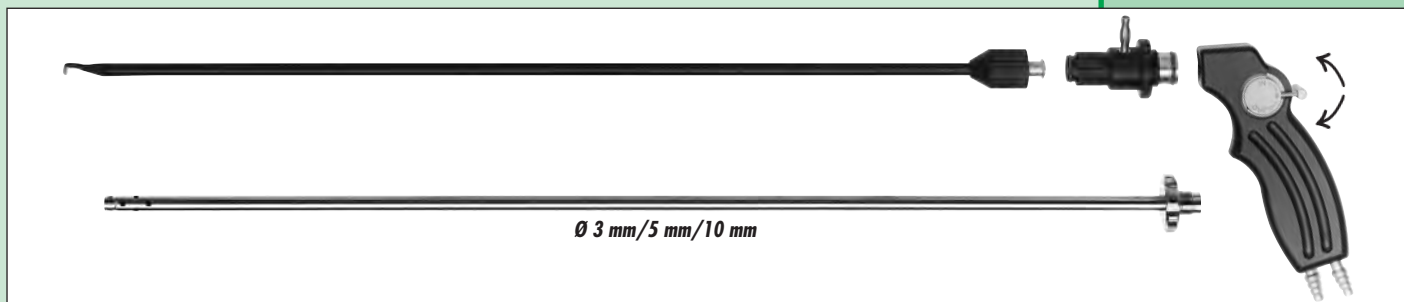

429-80040

### Suction-/Irrigation-Handle

- Ergonomic handle
- Slight swivelling
- 2 ways slide-valve
- Tube connections

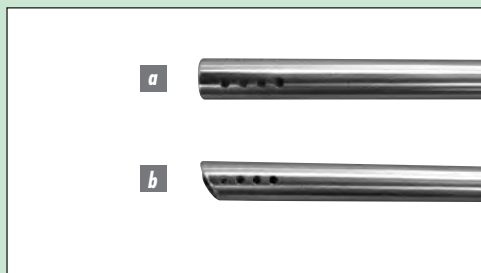

429-80044

**a** 429-80042

**b** 429-80038

429-80043

### Suction-/Irrigation Tubes for Handle (Order-No. 429-80040)

- Working length: 330 mm
- Tube Ø 3 mm
- a** ■ Tube Ø 5 mm
- b** ■ Tube Ø 5 mm distal oblique for magnetic trocars
- Tube Ø 10 mm



429-80041

### HF-Electrode-Adapter for Handle (Order-No. 429-80040)

- 360° rotatable

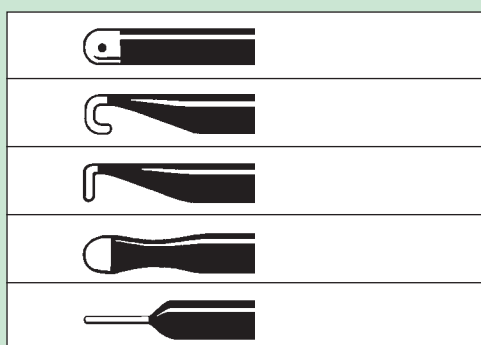

429-80045

429-80046

429-80047

429-80048

429-80049

### Electrodes with Channel

- Working length: 330 mm
- Button electrode
- J- Hook electrode
- L- Hook electrode
- Spatula electrode
- Needle electrode



## SUCTION- AND IRRIGATION

### Products

### Order-No.

### Description



429-80035

**Standard Suction-/Irrigation Pistol Handle**

- Connection M8 x 1



429-80039

**Suction-/Irrigation Handle**

- Ø 5 mm
- With sliding valve and tube connection
- Connection M8 x 1



429-80034

**Suction-/Irrigation Tube for M8 x 1**

- Working length: 330 mm

429-80032

- Tube Ø 3 mm

429-80033

- Tube Ø 5 mm

- Tube Ø 10 mm



429-80036

**Suction-/Irrigation Tube for M8 x 1**

- Working length: 330 mm
- Tube Ø 5 mm distal oblique for magnetic trocars

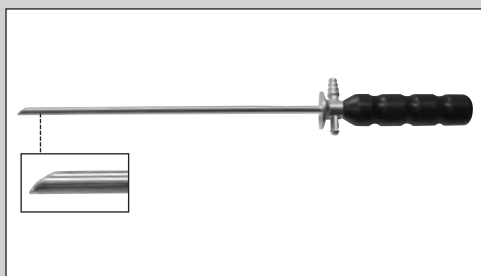

670-96330

**Irrigation Trocar for Glass Bottle**

670-96331

- 0.5 l

- 1.0 l

# INSTRUMENTS

## HF-MONOPOLAR INSTRUMENTS

Products

Order-No.

Description

Order-No.

Description

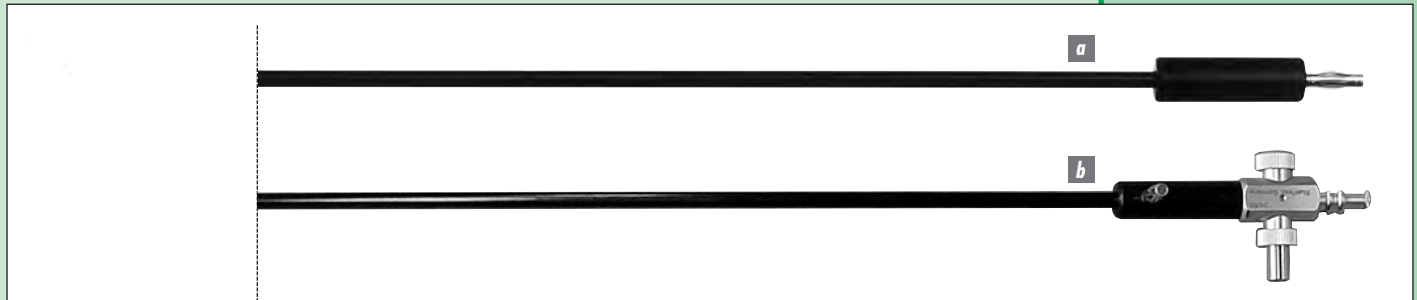

**Monopolar Standard Electrodes without Channel**

Working length: 330 mm

**Monopolar Electrodes with Trumpet Valve**

Working length: 330 mm

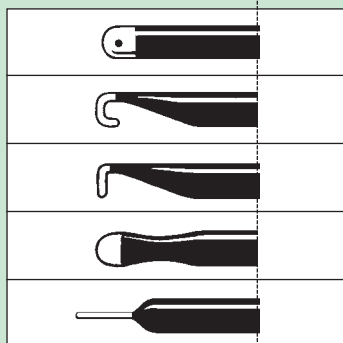

**a** 429-80061

**a** Button electrode

**b** 429-80001

**b** Button electrode

**a** 429-80062

**a** J- Hook electrode

**b** 429-80004

**b** J- Hook electrode

**a** 429-80063

**a** L- Hook electrode

**b** 429-80003

**b** L- Hook electrode

**a** 429-80064

**a** Spatula electrode

**b** 429-80002

**b** Spatula electrode

**a** 429-80065

**a** Needle electrode

**b** 429-80025

**b** Needle electrode

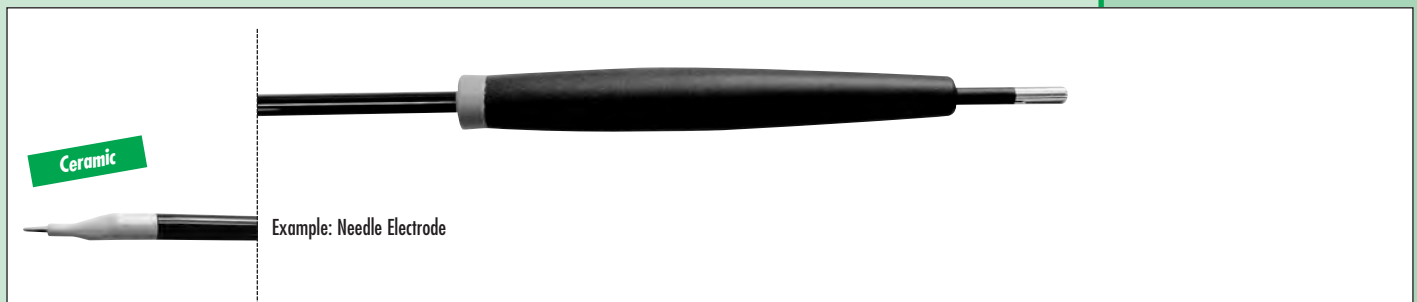

**Monopolar Standard Electrodes without Channel**

Working length: 330 mm

Ceramic

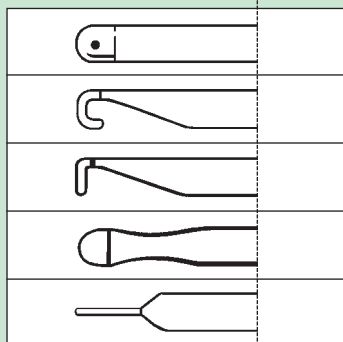

■ 429-80071

■ Button electrode

■ 429-80072

■ J- Hook electrode

■ 429-80073

■ L- Hook electrode

■ 429-80074

■ Spatula electrode

■ 429-80075

■ Needle electrode

## ACCESSORIES

### Products

### Order-No.

### Description



429-80050

#### Suction- Irrigation-Handle

- Large tube connector
- Sidewise Luer-Lock connection

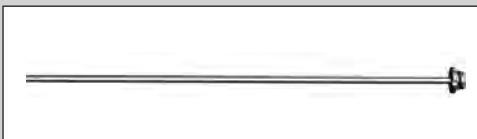

429-80051

#### Suction- Irrigation-Tube Ø 5 mm

- Working Length: 330 mm
- For Order-No.: 429-80050

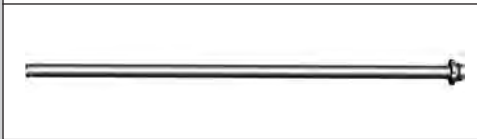

429-80052

#### Suction- Irrigation-Tube Ø 10 mm

- Working Length: 330 mm
- For Order-No.: 429-80050

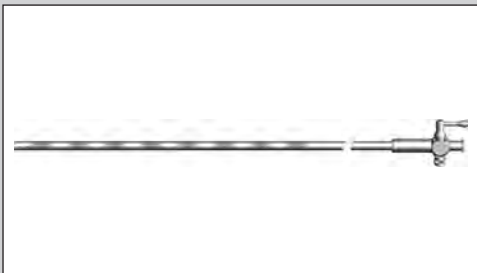

429-80055

#### Suction- Irrigation-Cannula Ø 5 mm

- Ø 5 mm
- Working Length: 330 mm
- Luer connection
- Stop cock



670-91320

#### Connection Cable for Disposable Neutral Electrodes

- 5 m

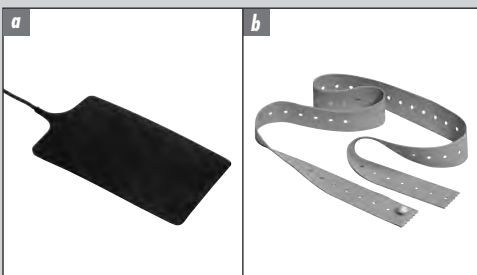

**a** 670-91313

#### **a** Neutral Electrode

- Reusable

**b** 670-91311

#### **b** Rubber Band

- For reusable neutral electrodes
- 1 m

# BIPOLAR

## BIPOLAR COAGULATION INSTRUMENTS

Ø 5 mm

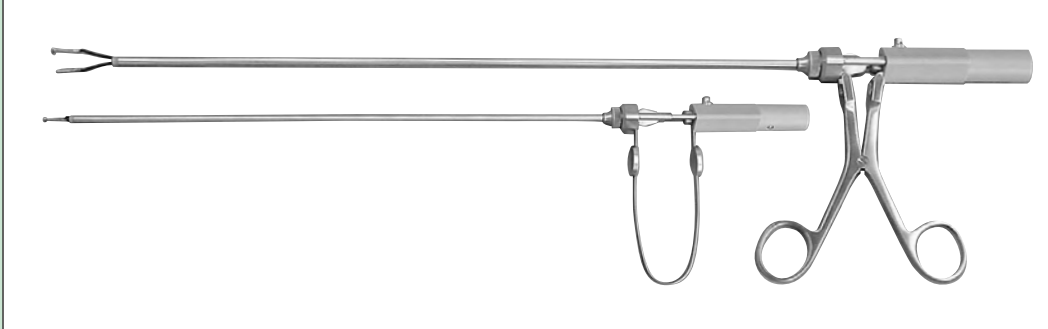

### Products

### Order-No.

### Description

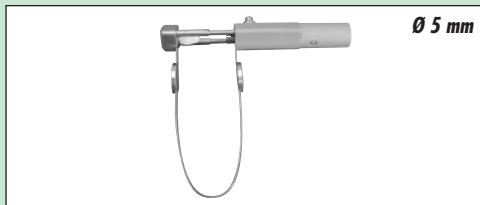

429-70050  
(Picture)

**Spring Handle**  
■ Standard plug

670-91338

**Connection Cable for  
Bipolar Tweezers**



429-70060

**Scissors Handle**  
■ Standard plug



429-70070

**Shaft**  
■ Stainless steel

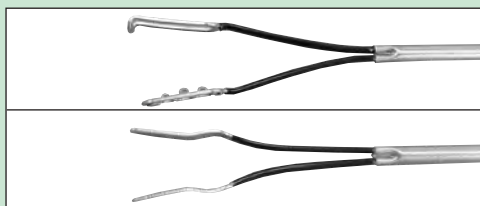

429-70071

**Tubal Coagulation Forceps  
Electrode**

■ Width: 4.5 mm

429-70072

**Plate Electrode**

■ Width: 3.0 mm

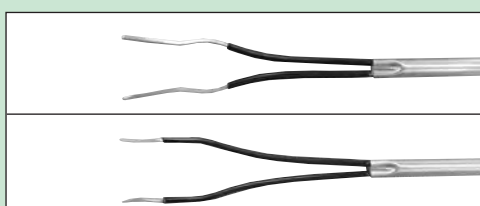

429-70073

**Tweezers Electrode**

■ Width: 1.5 mm

■ With short isolation

429-70074

**Tweezers Electrode**

■ Width: 1.5 mm

■ With long isolation

# BIPOLAR

## BIPOLAR COAGULATION INSTRUMENTS

### Products

### Order-No.

### Description

Ø 5 mm

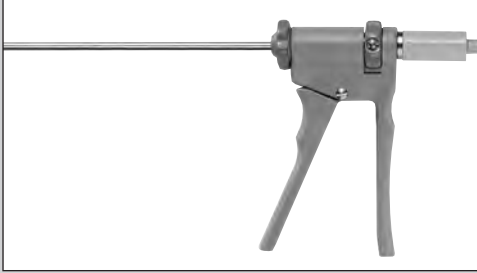

429-81005

#### Coagulation Forceps with Standard Handle

- 360° rotatable
- Max. output: 60 W
- Working length: 340 mm
- Detachable
- Inclusive shaft

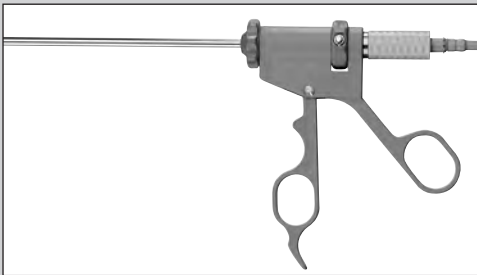

429-81023

#### Coagulation Forceps with Ring Handle

- 360° rotatable
- Max. output: 60 W
- Working length: 340 mm
- Detachable
- Inclusive shaft

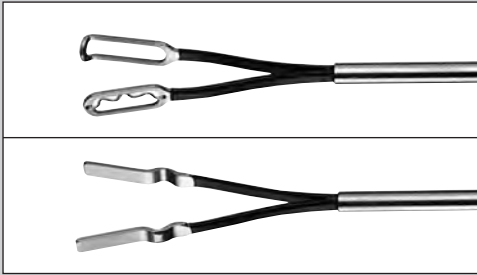

429-81007

#### Tubal Coagulation Forceps Electrode

- Rippled bar



429-81008

#### Plate Electrode

- Tong-type bit: 3 mm

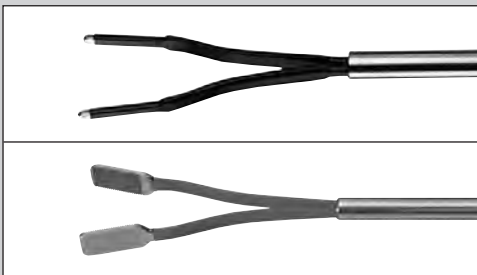

429-81011

#### Tweezers Electrode

- Tweezers tip: 1 mm



429-81024

#### Kleppinger Electrode

- Serrated



429-81025

#### Maryland Dissector

- Curved

## BIPOLAR COAGULATION INSTRUMENTS

### Products

### Order-No.

### Description

Ø 5 mm



429-81015

**Scissors Electrode with TC Blade**

- Curved



429-81026

**Scissors Electrode**

- Curved

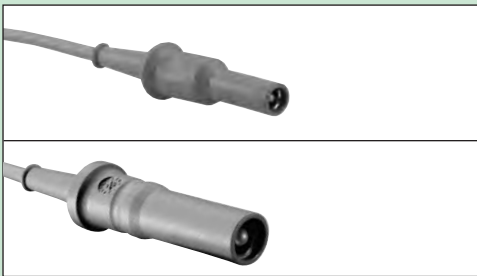

429-81010

**Bipolar Connection Cable**

- To Martin-, Berchtold-units
- For Order-No.: 429-81005, 429-81023



429-81021

**Bipolar Connection Cable**

- To Erbe-units
- For Order-No.: 429-81005, 429-81023



429-81019

**Bipolar Connection Cable**

- To MGB-units
- For Order-No.: 429-81005, 429-81023



429-81020

**Bipolar Connection Cable**

- To Valleylab-units
- For Order-No.: 429-81005, 429-81023

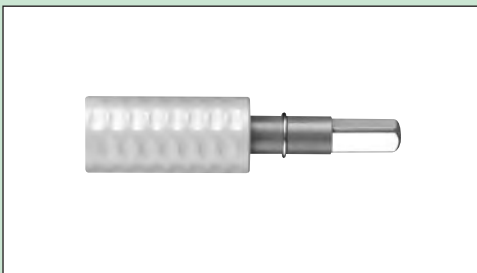

429-81018

**Adapter for Bipolar Cable with Flat Plug**

- E.g. usable with MGB-cable (Order-No.: 670-91331)
- For Order-No.: 429-81005, 429-81023

# BIPOLAR

## BIPOLAR COAGULATION INSTRUMENTS

Products

Order-No.

Description

Ø 3 mm

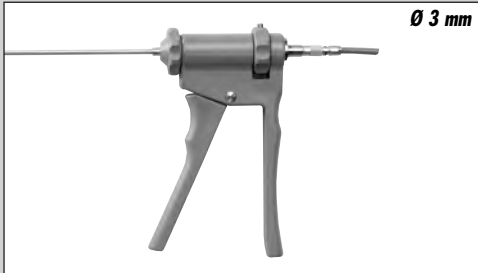

429-81305

**Bipolar Micro Coagulation Forceps**

- With standard handle
- Working length: 340 mm

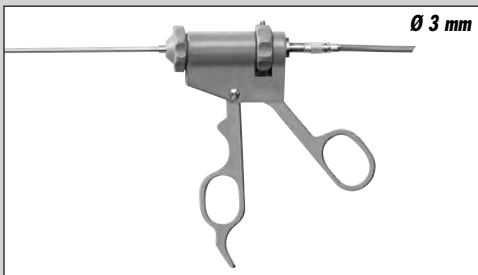

429-81323

**Bipolar Micro Coagulation Forceps**

- With ring handle
- Working length: 340 mm

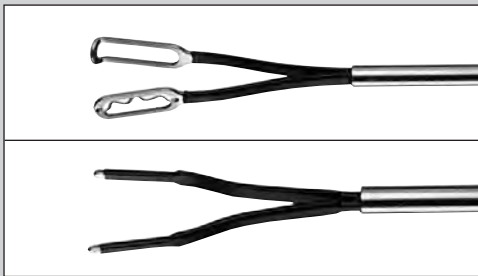

429-81311

**Micro Tubal Coagulation Forceps Electrode**

- Rippled bar



429-81308

**Micro Tweezers Electrode**

- Tweezers tip: 1 mm

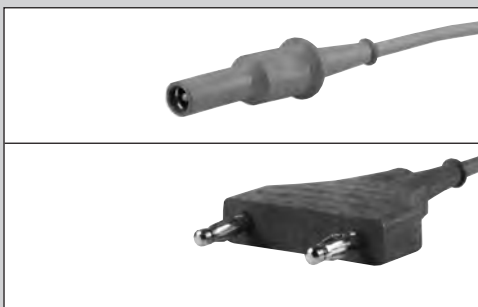

429-81310

**Bipolar Connection Cable for Ø 3 mm Instruments**

- To Martin-, Berchtold- units
- For Ø 3 mm- handles
- For Order-No.: 429-81305, 429-81323



429-81320

**Bipolar Connection Cable for Ø 3 mm Instruments**

- To Valleylab-units
- For Ø 3 mm- handles



429-81319

**Bipolar Connection Cable**

- For MGB-units
- For Ø 3 mm- handles
- For Order-No.: 429-81305, 429-81323



429-81321

**Bipolar Connection Cable**

- For Erbe-units
- For Ø 3 mm- handles
- For Order-No.: 429-81305, 429-81323

# BIPOLAR

## BIPOLAR COAGULATION FORCEPS

Products

Order-No.

Description

Ø 5 mm



Consist of:

- Handle (Order-No.: 429-81500)
- Shaft (Order-No.: 429-81510)
- Inserts (Order-No.: 429-81540, 429-81520, 429-81530)

**Bipolar Instrument**

- For active, precise opening and closing by isolated inserts
- 360° rotatable



429-81500

**Handle**

- Standardized plug
- PEEK polymer

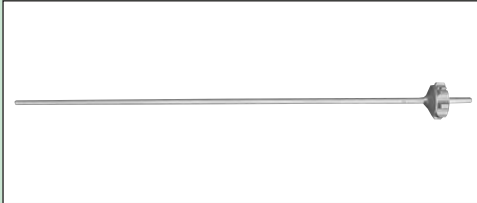

429-81510

**Shaft**

- Working length: 340 mm
- Ø 5 mm

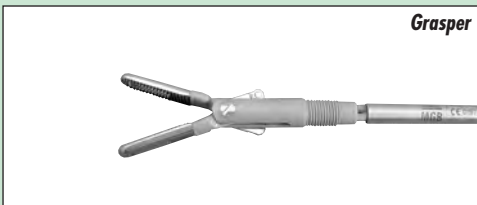

**Grasper**

429-81520

**Insert Bipolar Grasping Forceps**

- With join

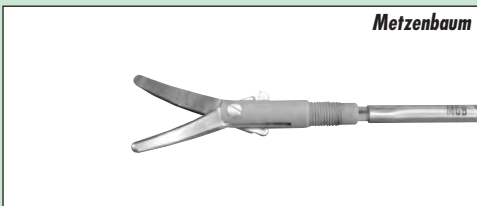

**Metzenbaum**

429-81530

**Insert Bipolar Scissors**

- With join

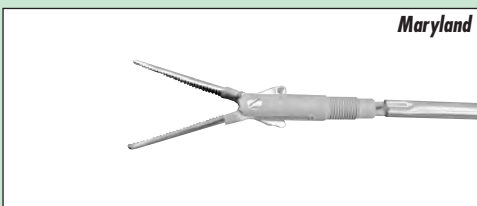

**Maryland**

429-81540

**Insert Bipolar Dissector**

- With join



# BIPOLAR

## BIPOLAR ELECTRODES

**Products**

**Order-No.**

**Description**

Ø 5 mm

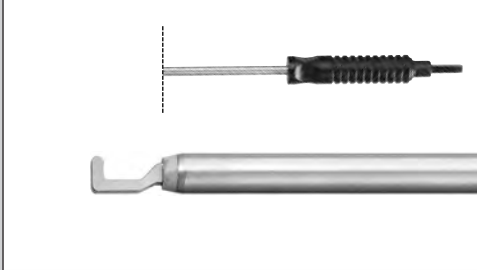

429-81031

*Bipolar L-Hook Electrode*

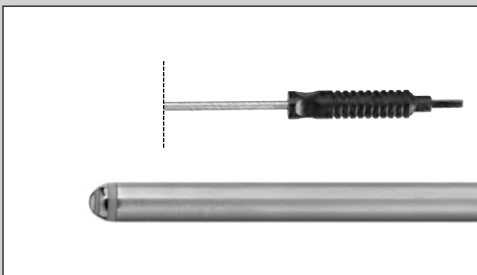

429-81032

*Bipolar Cup Electrode*

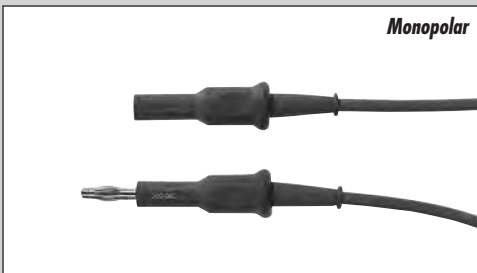

*Monopolar*

670-91330 (Picture)

670-91333

*Connection Cable for Monopolar MIS-Instruments*

- To MGB-, Martin-, Berchtold-units
- To Valleylab-units

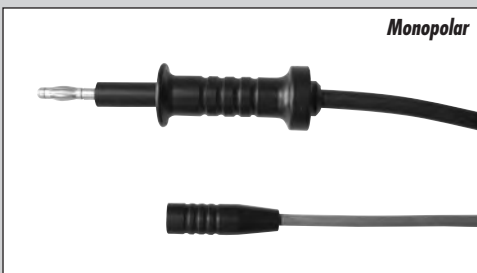

*Monopolar*

670-91332 (Picture)

670-91337

670-91336

*Connection Cable for MGB-Resectoscopes*

- To MGB-, Martin-, Berchtold-units
- To Valleylab-units
- To Erbe-, Storz-units

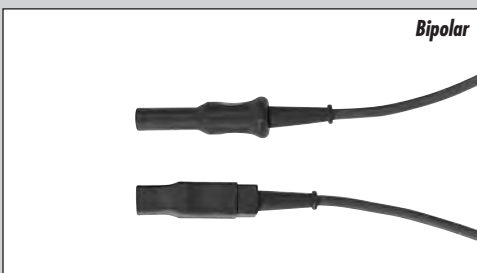

*Bipolar*

670-91331 (Picture)

670-91334

670-91335

*Connection Cable for Bipolar Tweezers*

- To Martin-, Berchtold-units
- To MGB-, Valleylab-units
- To Erbe-, Storz-units

## ML-G INSUFFLATOR

Order-No.: 670-95600 (220 V)  
670-95601 (110 V)



40 Liter/min  
Insufflation

For our new insufflators  
ME-GX & ML-GX please see  
our brochure "Insufflators"

### Specification

The latest computer controlled technology for safe and precise insufflation. 4 unique selectable flow standards for exact control of intermittent insufflation (2 l, 8 l, 40 l/min automatic mode). The adjustable preselection of intraabdominal pressure (1-30 mm/Hg) meets every requirement (paediatric, gynaecology, general laparoscopy and bariatric procedure).

### High Safety

The ML-G guarantees the highest safety based on electrical control. Additionally, it covers all functions mechanically. Abdominal overpressure will be automatically reduced through integrated gas valve.

### Clear Arrangement

Clear arrangement is the essential characteristics of the ML-G. Its display gives a quick overview of the rated and actual values of gas flow- and-pressure. The setting of the flow rate is made by a simple touch of a button. The gas volume is shown by a separate display.

### Compatibility

ML-G is compatible to central CO<sub>2</sub> supply or different kind of gas bottles.



### Insufflation medium: CO<sub>2</sub> Insufflation Rate

**Low:** approx. 2 l/min.  
**Med:** approx. 8 l/min.  
**High:** approx. 40 l/min.  
**Auto:** automatic flow



### Irrigation Included

The ML-G has a gas pressure Irrigation function, which allows liquids irrigation. In combination with the MGB-Suction-/Irrigation instrument, simple handling and high flow Irrigation is guaranteed.



### Voice Feedback

All settings are confirmed acoustically through an adjustable speech module.

## GENERAL

Order-No.	
670-95600	ML-G Insufflator 220 V
670-95601	ML-G Insufflator 110 V
Main Connection	
Power supply	100 - 120 V/200 - 240 V
Frequency	50 - 60 Hz
Power consumption	45 VA
Fuse (~100 - 120 V)	2 x T 1.0 A/250 V (IEC 127)
Fuse (~200 - 240 V)	2 x T 2.0 A/120 V (IEC 127)
Classification	
Safety class	1 with potential equalization connection
Protection	IP X 1
Type	BF
Approval	CE
Dimension and Weight	
Dimension (w/h/d)	400 x 200 x 400 mm (without gas bottle)
Weight	17.6 kg
Operating Conditions	
Operating temperature	+10° C ~ +40° C
Operating humidity	30 % ~ 75 %
Extent of Delivery	
ML-G	<ul style="list-style-type: none"> <li>■ Silicone tube set for Insufflation</li> <li>■ Disposable Filter for Insufflation</li> <li>■ Adapter for Insufflation</li> <li>■ Silicone tube set for Irrigation</li> <li>■ Power cable</li> </ul>
	<ul style="list-style-type: none"> <li>■ User manual</li> </ul>
Interface	
To patient	<ul style="list-style-type: none"> <li>■ Gas connection: conus</li> </ul>
CO <sub>2</sub> connection	<ul style="list-style-type: none"> <li>■ Irrigation connection: Luer (male)</li> <li>■ DIN</li> </ul>

## SPECIFICATION

Main Unit	
Insufflation medium: CO <sub>2</sub> , Insufflation rate	<ul style="list-style-type: none"> <li>■ <b>Low:</b> approx. 2 l/min</li> <li>■ <b>Med:</b> approx. 8 l/min</li> <li>■ <b>High:</b> approx. 40 l/min</li> <li>■ <b>Auto:</b> automatic flow</li> </ul>
Intra-abdominal working pressure	<ul style="list-style-type: none"> <li>■ 0-30 mm Hg infinitely selectable and limitable</li> <li>■ Maximal pressure of bottle: 80 bar</li> <li>■ Display of critical low bottle pressure</li> <li>■ Irrigation P+: 800 mbar</li> </ul>

Order-No.	Accessories
670-95300	Silicone tube set for Insufflation
670-95310	CO <sub>2</sub> gas bottle 1l (empty)
670-95311	Key for CO <sub>2</sub> gas bottle connection
670-95313	High pressure tube, GI:DIN, bottle: DIN
670-95314	High pressure tube, GI:DIN, bottle: PIN
670-95316	High pressure tube, GI:DIN, bottle: ITALY
670-95341 (100 mm) 670-95342 (120 mm) 670-95340 (150 mm)	Veress needle, Ø 2 mm
675-11200	Gas-filter, 25 pieces
675-11202	Adapter for Insufflation
670-95301	Silicone tube set for Irrigation
670-96330	Irrigation trocar, short (0.5 l)
670-96331	Irrigation trocar, long (1.0 l)
670-96325	Irrigation bottle holder for cart
670-96310	Filter for Irrigation, 10 pieces

# LAP-PUMP

## PUMP FOR LAPAROSCOPY

Order-No.: 670-96100



### Specification

- Simple and noiseless operation
- Easy to load latex-free tube set
- High safety
- Suction included
- To use with fluid bag

### Suction-/Irrigation - Pistol Handle

- Ergonomic handle
- Slight swivelling
- 2 ways slide-valve
- Tube connections
- See page 32, 33
- Assembled of  
Order-No.: 429-80040,  
429-80044,  
429-80042,  
429-80043

## GENERAL

## SPECIFICATION

Order-No.	
670-96100	Laparoscopy - Pump
Main Connection	
Power supply	<ul style="list-style-type: none"> <li>■ ~ 100 V AC</li> <li>■ ~ 110 - 115 V AC</li> <li>■ ~ 220 - 240 V AC</li> </ul>
Frequency	50 - 60 Hz
Power consumption	55 VA
Fuse	2 x T 2, 0A/250 V
Classification	
Safety class	1 with potential equalization connection
Protection	IP 41
Type	BF
Approval	CE
Dimension and Weight	
Dimension (w/h/d)	280 x 137 x 408 mm
Weight	5.9 kg
Extent of Delivery	
Laparoscopy - Pump	<ul style="list-style-type: none"> <li>■ Main power cable</li> <li>■ User manual</li> </ul>

Main Unit	
Max. flow rate Irrigation	1.8 l/min. (± 10 %)
Suction	1.8 l/min. (+ 0.4/-0.1 l/min.)
Max. pump capacity	400 mm Hg (± 50 mm Hg)
Suction	Between -50 kpa and -60 kpa

Order-No.	Accessories
670-96410	Limited use tubing set (irrigation)
670-96420	Disposable tubing set (irrigation)
670-96460	10 x membrane for pressure chamber for limited use tubing set (spare-part)
670-96480	Limited use tubing set (vacuum)
670-96490	Limited use tubing set (suction)

# MORCELLATOR

## MORCELLATOR »SET POWER«

Order-No.: 429-10100

### Set consists of:

- Control Unit
- Motor
- Gear box
- Cable

### Attention

Cutting tube is not content of this set!

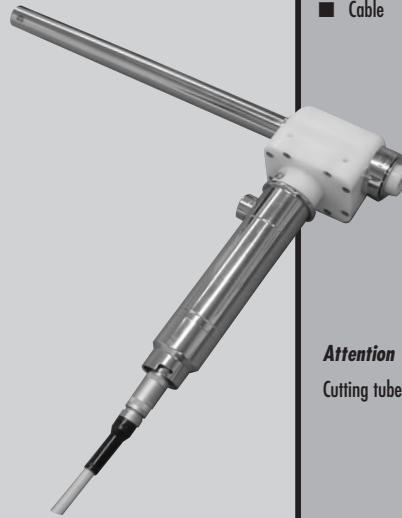

### Morcellator »Set Power«

- Uncomplicated and time-saving tissue Morcellation
- Riskless intraabdominal Morcellation of large tissues
- Tissue cylinders can be removed from Myomas, Uteri, Renal and Splenic tissues etc. by motorized rotation of the SET-POWER in a continuous and precise mode
- SET-POWER is operated by mains connection
- Constant torsional moment: no decrease in performance (when treating big and hard Myomas)
- Maintenance-free world power supply (100-240 V)
- Motor, gear and Morcellator tubes are connected by rapid coupling
- Function ON/OFF at the motor handle
- Ergonomically shaped handle guarantees optimal handling
- Useable for cutting tubes toothed edge (10 mm/15 mm/20 mm)
- Operating display of SET-POWER in the controlling unit
- Gear box autoclaveable at 134 °C
- Drive Motor autoclaveable at 134 °C by means of protective caps
- Cable length 3 m

## GENERAL

Order-No.	
429-10100	Morcellator »Set Power«
Main Connection »Set Power«	
Power supply	~100 - 240 V AC
Frequency	50 - 60 Hz
Power consumption	110 VA
Classification »Set Power«	
Safety class	1 with potential equalization connection
Type	BF
Approval	CE
Dimension and Weight »Control Unit«	
Dimension (w/h/d)	350 x 90 x 290 mm
Weight	3.6 kg
Extent of Delivery »Set Power«	
Morcellator »Set Power«	<ul style="list-style-type: none"> <li>■ Control unit</li> <li>■ Gear box</li> <li>■ Handbox</li> <li>■ Cable</li> </ul>

## SPECIFICATION

Dimension and Weight »Motor/Gear box«	
Dimension (w/h)	175 x 41 mm
Weight	0.94 kg

Order-No.	Accessories
429-10300	Cutting tube Ø 10 mm (5 mm Instr.)
429-10400	Cutting tube Ø 15 mm (10 mm Instr.)
429-10500	Cutting tube Ø 20 mm (10 mm Instr.)
429-90021	Sealing caps for Ø 15 mm/Ø 20 mm cutting tubes
429-90020	Sealing caps for Ø 10 mm cutting tubes

## ACCESSORIES FOR MORCELLATOR

### Products

### Order-No.

### Description

Working Length: 245 mm



429-10300  
429-10400  
429-10500  
429-90021  
429-90020

#### Cutting Tubes Toothed Edge

- Ø 10 mm (5 mm Instr.)
- Ø 15 mm (10 mm Instr.)
- Ø 20 mm (10 mm Instr.)
- Sealing caps for Ø 15, Ø 20 mm cutting tubes
- Sealing caps for Ø 10 mm cutting tubes

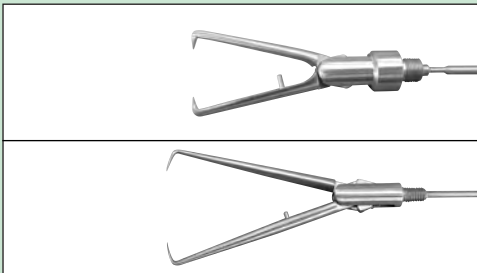

429-75282/44  
  
429-75283/44

#### Insert Tenaculum

- Ø 10 mm for 440 mm shafts
- Ø 5 mm for 440 mm shafts

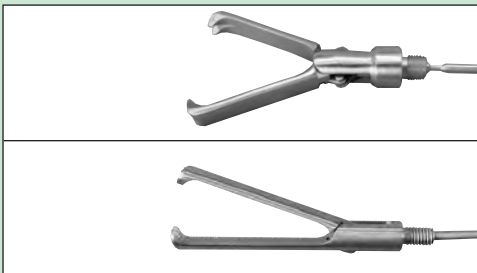

**a** 429-75281/44  
(For 440 mm shafts)  
  
**b** 429-75171/44  
(For 440 mm shafts)

#### **a** Insert Claw Forceps Ø 10 mm

- 2 to 3 teeth
- Sharp
- Double action

#### **b** Insert Claw Forceps Ø 5 mm

- 2 to 3 teeth
- Sharp
- Double action



429-77030

#### GRP-Laparoscopic Handle Polymer with Ratchet

- With HF-connection
- Fibre-reinforced

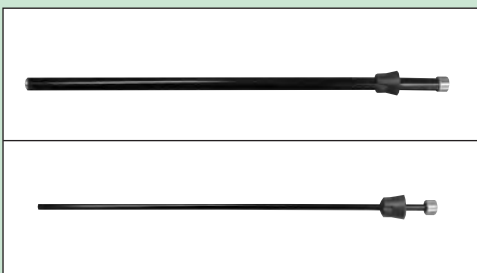

429-75061/44  
  
429-75065/44

#### Insulated Shaft with Shaft knob Ø 10 mm

- Working length: 440 mm

#### Insulated Shaft with Shaft knob Ø 5 mm

- Working length: 440 mm

## ACCESSORIES FOR MORCELLATOR

### Products

### Order-No.

### Description



429-10600

#### Myoma Drill

- Ø 10 mm
- Working length: 420 mm

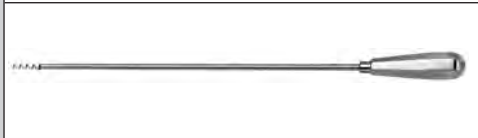

429-10650

#### Myoma Drill

- Ø 5 mm
- Working length: 420 mm



429-40022

#### Flap Valve Trocar Sleeve

- Ø 11 mm
- Working length: 101 mm

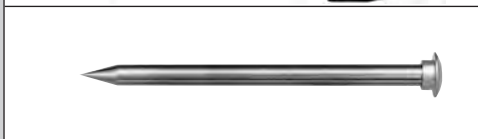

429-40133

#### Conical Trocar

- Ø 11 mm
- Working length: 193 mm

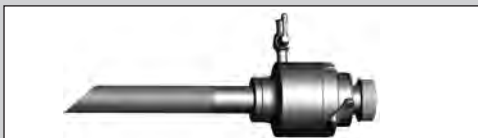

429-40041 (Ø 15 mm)  
429-40042 (Ø 20 mm)

#### Flap Valve Trocar Sleeve

- Working length: 110 mm
- Working length: 120 mm



429-90022 (2 pcs.)  
429-90021 (2 pcs.)  
429-90020 (2 pcs.)

#### Sealing Caps

- Ø 10 mm/Ø 10.5 mm/Ø 11.0 mm
- Ø 15 mm
- Ø 20 mm



429-23212

#### Dilatation Sleeve with Rod

- Ø 11 mm - Ø 15 mm

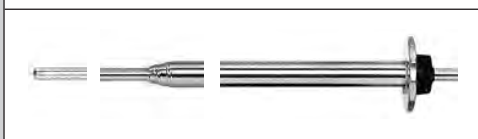

429-23215

- Ø 11 mm - Ø 20 mm



429-10250

#### Hand Wheel

- For Ø 10 mm/Ø 15 mm and Ø 20 mm cutting tubes

# MGB BERLIN

## PERFECTION BY PRECISION

*General Surgery – Laparoscopy*

*Urology – Cystoscopy – Ureterorenoscopy – Nephroscopy – Resectoscopy*

*Gynecology – Hysteroscopy – Resectoscopy*

*Arthroscopy – Shaver System*

### *Electronic Devices for all Applications*

- Video-Cameras
- Light-Sources
- Gas-Insufflators
- Pumps
- Monitors
- Disto II Digital Storage
- Shaver
- RF-Surgical Device



MGB Endoskopische Geräte GmbH Berlin  
Schwarzschildstraße 6 · 12489 Berlin, Germany  
Phone: +49-30-63 92-70 10  
Fax: +49-30-63 92-70 11  
E-mail: sales@mgb-berlin.de  
Internet: www.mgb-berlin.de

